

	Customer	Customer (P/N)	Description LR ANTENNA 265mm 125μH 6% 125kHz		
	Premo (P/N) KGEA-LR-B-0125J	Prototype Ref.	Date 19/04/24	Edition 2	Page 1/5

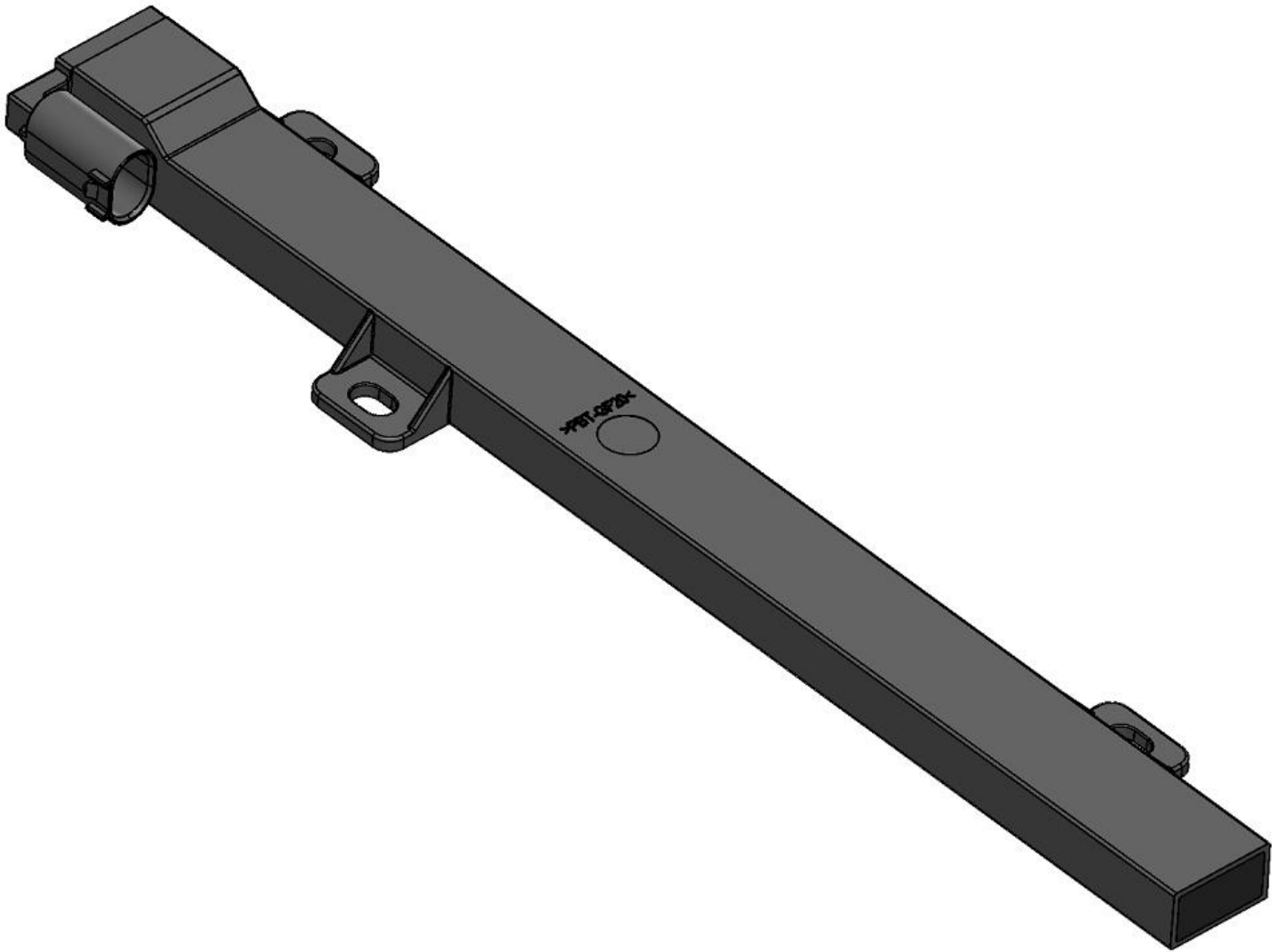

KGEA-LR-B-0125J: LR Antenna 265mm 125μH 6% 125kHz

Made by: Jose Ramón Fdez	Checked by:	Approved by:
Date: 19/04/2024	Date:	Date:

	Customer	Customer (P/N)	Description		
	Premo (P/N) KGEA-LR-B-0125J	Prototype Ref.	Date 19/04/24	Edition 2	Page 2/5
LR ANTENNA 265mm 125μH 6% 125kHz					

Signature: 	Signature:	Signature:
--	-------------------	-------------------

	Customer	Customer (P/N)	Description LR ANTENNA 265mm 125μH 6% 125kHz		
	Premo (P/N) KGEA-LR-B-0125J	Prototype Ref.	Date 19/04/24	Edition 2	Page 3/5

7.- H-field (Electromagnetic field strength):

7.1. Setup

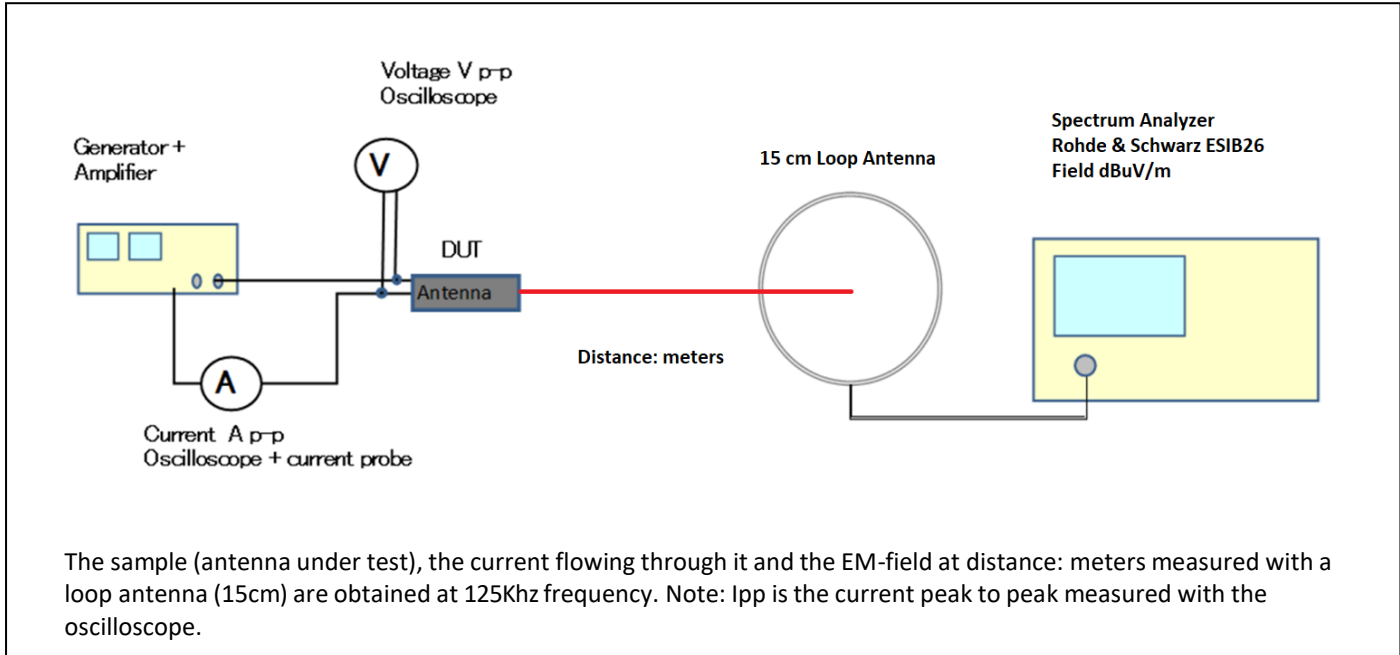

7.3 Orientation loop-antenna Vs Premo Antenna

Measuring Conditions



	Customer	Customer (P/N)	Description LR ANTENNA 265mm 125μH 6% 125kHz		
	Premo (P/N) KGEA-LR-B-0125J	Prototype Ref.	Date 19/04/24	Edition 2	Page 4/5

7.2-Results

Magnetic Field H (dBmV/m) @125kHz	1,2m	2m	3m	4m	5m
1A	134,10	122,00	112,30	106,70	100,90
2A	140,30	128,20	118,50	112,40	107,20
3A	143,80	131,70	121,90	116,00	110,90
4A	147,25	134,25	124,40	118,55	113,30

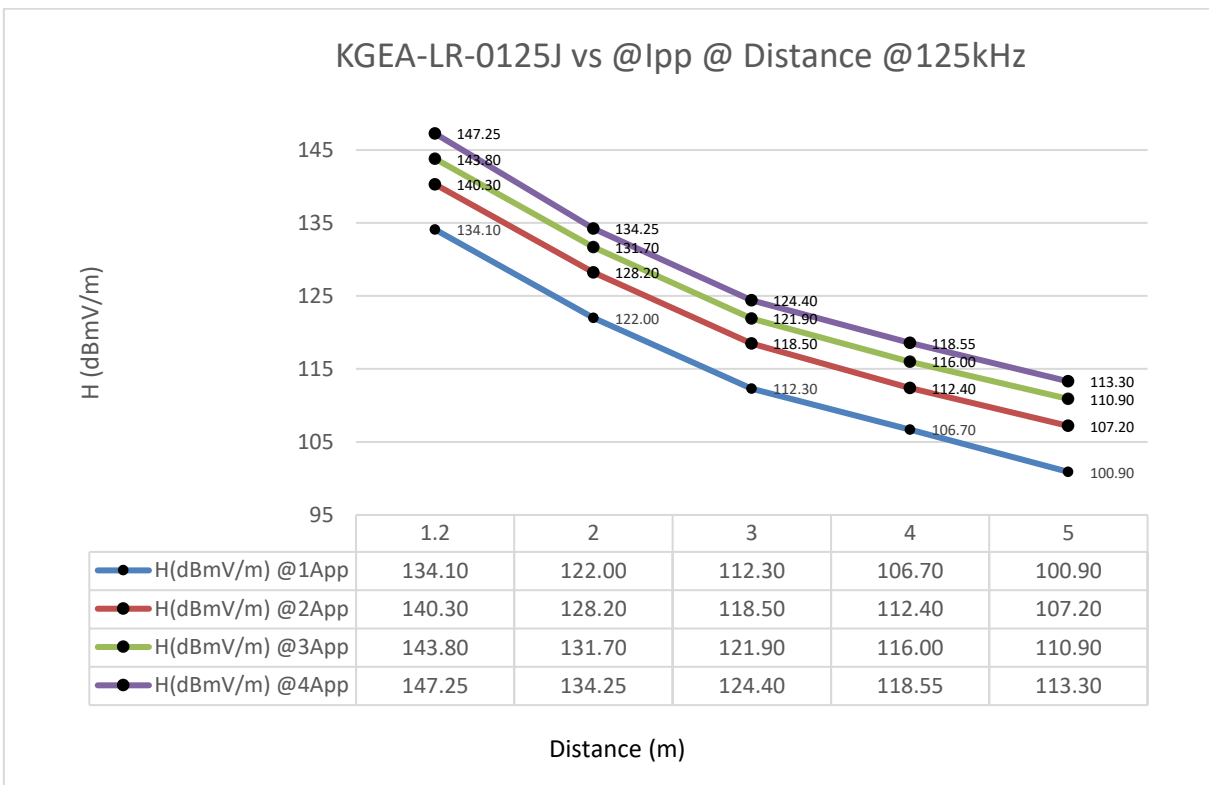

	Customer	Customer (P/N)	Description		
	Premo (P/N) KGEA-LR-B-0125J	Prototype Ref.	Date 19/04/24	Edition 2	Page 5/5

